

# CUB SCOUT SHOOTING SPORTS GUIDE

A GUIDE TO THE CUB SCOUT SHOOTING SPORTS AWARDS FOR UNIT LEADERS, COUNCILS, DISTRICTS, AND RANGE MASTERS



BOY SCOUTS  
OF AMERICA®



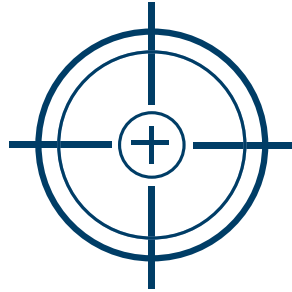

# CUB SCOUT SHOOTING SPORTS GUIDE

A GUIDE TO THE CUB SCOUT SHOOTING SPORTS AWARDS FOR UNIT  
LEADERS, COUNCILS, DISTRICTS, AND RANGE MASTERS



BOY SCOUTS  
OF AMERICA®

# A WORD ABOUT YOUTH PROTECTION

Child abuse is a serious problem in our society and, unfortunately, it can occur anywhere, even in Scouting. Because youth safety is of paramount importance to Scouting, the Boy Scouts of America continues to strengthen barriers to abuse through its policies and leadership practices, through education and awareness for youth, parents, and leaders, and through top-level management attention to any reported incidents.

## KEY TO SUCCESS: LEADERSHIP EDUCATION AND TRAINING

Registered leaders are required to complete Youth Protection training within 30 days of registering.

Parents, guardians, and any adults working with youth (whether in Scouting or not) are also encouraged to take the training.

To take the training online, go to [www.myscouting.org](http://www.myscouting.org) and establish an account. If you do not yet have your membership number, be sure to return to MyScouting later and enter your number for training record credit.

**The training must be taken every two years to remain current.** If a volunteer does not meet the BSA's Youth Protection training requirement at the time of recharter, the volunteer will not be reregistered.

## BSA YOUTH PROTECTION TRAINING

The BSA created Youth Protection training to address the needs of different age groups as follows.

- **Youth Protection Training for Volunteer Leaders and Parents—** Adults come away with a much clearer awareness of the kinds of abuse, the signs of abuse, and how to respond and report should a situation arise.
- **Youth Protection Guidelines: Training for Adult Venturing Leaders—** Designed to give guidance to the leaders in our teenage coed Venturing program. Supervision and relationship issues have a different focus regarding personal safety with this age group.
- **It Happened to Me—** Developed for Cub Scout-age boys from 6 to 10 years old and their parents. It addresses the four rules of personal safety: Check first, go with a friend, it's your body, and tell.
- **A Time to Tell—** A video for Boy Scout-age boys from 11 to 14 years old—the target group for most molesters. It stresses the three R's of youth protection: Recognize, Resist, and Report.
- **Personal Safety Awareness for Venturing—** Developed for youth ages 13 through 20 in the coeducational Venturing program. It deals with issues pertinent to this age group.

The BSA has Youth Protection policies to protect youth, and these same policies help protect adult volunteers. These and other key policies are addressed in the training:

- Two-deep leadership is required on all outings.
- One-on-one contact between adults and youth members is prohibited.
- Privacy of youth is respected.
- Separate accommodations for adults and Scouts are required.
- Units are responsible to enforce Youth Protection policies.

To find out more about the Youth Protection policies of the BSA and how to help Scouting keep your family safe, see the *Guide to Safe Scouting* at [www.scouting.org/HealthandSafety/GSS/toc.aspx](http://www.scouting.org/HealthandSafety/GSS/toc.aspx) and the Parent's Guide in any of the Cub Scouting or Boy Scouting handbooks, or go to [www.scouting.org/Training/YouthProtection.aspx](http://www.scouting.org/Training/YouthProtection.aspx).



# PREFACE

Cub Scout shooting sports programs may be conducted only on a district or council level. Archery, BB gun shooting, and slingshot shooting are restricted to day camps, Cub Scout/Webelos Scout resident camps, council-managed family camping programs, or council activities where there are properly trained supervisors and where all standards for BSA shooting sports are enforced. All shooting ranges in the Cub Scout program must be supervised by a qualified range master who is at least 18 years of age and meets the minimum requirements. See specific qualifications and training requirements for Cub Scout shooting sports range masters in the *Boy Scouts of America National Shooting Sports Manual*, No. 430-938.

## USING THIS GUIDE

- Archery, BB gun shooting, and slingshot shooting are not approved unit activities.
- The use of pellet air rifles is restricted to Webelos Scouts in a Boy Scouts of America resident camp setting only.
- Kindergarten-age boys in the Lion pilot program are not approved to participate in Cub Scout shooting sports activities.
- **The Multi-Gun Airsoft Experience introduced in August 2015 was not designed for participation in this award. Airsoft guns are not approved for use in the Cub Scout shooting sports program.**
- **All local, state, and federal laws for BB guns, archery, and slingshot shooting must be followed.**

This *Cub Scout Shooting Sports Guide* is intended to assist leaders in helping their Cub Scouts earn the shooting sports awards. It is not a substitute for authorized range master training or for the safety procedures called out in the *Boy Scouts of America® National Shooting Sports Manual*, No. 430-938, which is the reference for any shooting sports activities in the Boy Scouts of America.

**All volunteers participating in official Scouting activities should become familiar with the *Guide to Safe Scouting*. The *Guide to Safe Scouting* may be found online at [www.scouting.org/scoutsource/HealthandSafety/GSS](http://www.scouting.org/scoutsource/HealthandSafety/GSS).**



# CONTENTS

## SECTION 1

- 07** Introduction
- 07** Purpose of the Cub Scout Shooting Sports Awards
- 08** Structure of the Cub Scout Shooting Sports Awards

## SECTION 2

- 09** Award Requirements and Explanations
- 09** BB Gun
- 16** Archery
- 24** Slingshot

## APPENDIX

- 28** Resources for the Cub Scout Shooting Sports Awards
- 28** Posters
- 48** Additional Activities

## SECTION 1: INTRODUCTION

The goal of the *Cub Scout Shooting Sports Guide* is to support shooting sports directors, range masters, on-range adult volunteers, and unit leaders as they assist Cub Scouts in meeting the requirements of the Cub Scout shooting sports awards according to Boy Scouts of America policy and practice. This resources supports—but does not replace—the *Boy Scouts of America National Shooting Sports Manual* (No. 430-938).

The Cub Scouting shooting sports disciplines of archery, BB gun shooting, and slingshot shooting are restricted to day camps, Cub Scout/Webelos

---

**Archery, BB gun shooting, and slingshot shooting are not approved unit activities.**

Scout resident camps, council-managed family camping programs, or council activities held on or off BSA property where there are current and properly trained BSA shooting sports range masters and where all standards for BSA shooting sports are enforced.

### PURPOSE OF THE CUB SCOUT SHOOTING SPORTS AWARDS

As decades of Cub Scouting have shown, most boys love to shoot!

Beyond capturing that enthusiasm, the BSA created the Cub Scout Shooting Sports Awards program to encourage in Cub Scouts the development of safe shooting practices and proficiency in shooting sports. As a Cub Scout participates in shooting sports activities and works toward an award, he not only builds confidence in his abilities, but he also develops self-reliance, sportsmanship, and conservation

---

**In the spirit of Cub Scouting, remember to “Keep It Simple, Make It Fun!” and guide Cub Scouts to follow their motto, “Do Your Best!”**

awareness—all elements of good character valued in Scouting.

Through experiential learning guided by a knowledgeable adult, Cub Scouts will learn the safe and responsible use of BB guns, slingshots, and archery equipment. The goal is for the Cub Scout to have fun in a safe environment, not to become an expert marksman, range master, or hunter.

### TIGERS AND SHOOTING SPORTS

Tigers and their adult partners may participate in all Cub Scouting shooting sports activities. The adult partners must be included in all shooting activities. Each Tiger must be paired with his adult partner before being allowed to shoot. In most cases, Tigers and their adult partners will participate in BB gun shooting at a day camp.

Keep in mind that boys of this age have very short attention spans (20 to 30 minutes, maximum) and tire easily. They probably have little experience working as a group and may require more time to understand how the range operates. Tigers have a wide range of ability and experience levels, so be ready for anything!

### STRUCTURE OF THE CUB SCOUT SHOOTING SPORTS AWARDS

Cub Scout shooting sports awards may be earned for any of the three following disciplines:

- Archery
- BB guns
- Slingshots

A Cub Scout may choose to participate in only one of the disciplines or he may choose to participate in all three disciplines. The requirements for each of the disciplines are structured similarly.

**Level 1** involves participation in a discipline and acquiring basic knowledge of proper technique, safety, and operations in that discipline.

**Level 2** is designed to help a Cub Scout develop and demonstrate further skills, proficiency, and knowledge in a shooting discipline. Level 2 requirements are rank-specific and provide a progression of skills appropriate to each age and rank of Cub Scouting.

## Earning the Awards

Cub Scouts earn the shooting sports awards in the following order:

1. **Rank-level patch.** Choose a discipline: BB gun, archery, or slingshot. Complete the level 1 requirements for that discipline. The patch is only awarded once per program (rank) year.
2. **Discipline device (pin).** Complete the level 2 requirements for the same discipline in which the patch was earned.
3. **Additional discipline devices.** Earn pins for the remaining disciplines by completing the level 1 and level 2 requirements in those disciplines. (NOTE: Requirements for both level 1 and level 2 must be completed for each successive discipline.)

**Disciplines:** BB gun, archery, slingshot

**Program years/ranks:** Tiger, Wolf, Bear, Webelos/Arrow of Light

### Sample situation:

A new Tiger completes the level 1 requirements for BB guns and earns the Tiger shooting sports patch at a day camp in his district. He then attends another day camp and completes the level 2 requirements

and earns the BB gun pin to attach to his patch. Later that year, his district holds a Cub Scout shooting sports day at the local park. This time he completes both the level 1 and level 2 for archery. He earns the archery pin, which he wears on his Tiger shooting sports patch.

---

**See section 2 for more information on awards and requirements.**

## SHOOTING SPORTS AWARDS



TIGER



WOLF



BEAR



WEBELOS

## SHOOTING SPORTS AWARD PINS

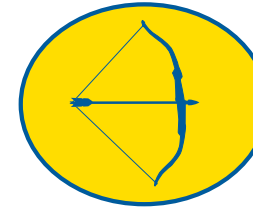



## SECTION 2: AWARD REQUIREMENTS AND EXPLANATIONS

### BB GUN LEVEL 1 REQUIREMENTS

#### LEVEL 1: PARTICIPATION AND KNOWLEDGE (ALL RANKS)

1. Explain what you should do if you find a gun. Recite the four safety reminders.
2. On an approved range in your city or state, explain how to use the safety mechanism, and demonstrate how to properly load, fire, and secure the BB gun.
3. On an approved range, demonstrate to qualified leadership good shooting techniques, including eye dominance, shooting shoulder, breathing, sight alignment, trigger squeeze, and follow-through.
4. On an approved range, show how to put away and properly store BB gun shooting equipment after use.

### TRAINING CUB SCOUTS

The objectives of this award are to teach Cub Scouts how to use a BB gun safely, to teach basic BB gun shooting skills, and to have fun. Cub Scouts should have the opportunity to fire a BB gun during the first orientation period. This activity is not intended to produce expert marksmen.

The instructor must always be mindful of his or her responsibility to make safety thoroughly understood before, during, and after instruction and practice. At the same time, he or she must have warmth, patience, and understanding for the boy who finds the skill difficult to learn.

### TEACHING TIPS

The coach-pupil method is effective for all types of skill training and is particularly effective in shooting sports. To put this method into practice:

- Put the BB gun in the Cub Scout's hand as soon as possible so he can understand the BB gun while the basics are explained.
- Group participants into pairs (boy and parent/guardian would be ideal).
- The instructor demonstrates the activity or action to be followed before the whole group. When demonstrating techniques, be sure to do them correctly.
- The instructor then circulates among the pairs giving a word of advice or assistance, recognizing good work, correcting errors, and determining how well the participants understood the method.
- The boy practices while the parent coaches. Let Scouts shoot the first round. At a predetermined signal, reverse the roles. Progressively, participants are learning by observing, by doing, and by coaching.
- Use a positive approach. Use praise sincerely. Before making a correction, question the fault to find the cause. Do show a boy what he is doing wrong.
- Avoid long discussions on the parts of the equipment used. Teach just enough so participants will know how to safely use the equipment.
- Allow each boy to feel the satisfaction of hitting a target as quickly as possible.

## NOTES ON BB GUN LEVEL 1 REQUIREMENTS

### Level 1, Requirement 1

*Explain what you should do if you find a gun. Recite the four safety reminders.*

This requirement should be reviewed while the Scouts are preparing for their turn on the range or in a pre-event activity. A lively chant will help them memorize the reminders.

### THE FOUR SAFETY REMINDERS

What should you do if you find a gun?



**STOP!**



**LEAVE THE AREA!**



**DON'T TOUCH!**



**TELL AN ADULT!**

### Level 1, Requirement 2

*On an approved range in your city or state, explain how to use the safety mechanism, and demonstrate how to properly load, fire, and secure the BB gun.*

#### Safety Guidelines

When training youth to shoot, be sure to have proper equipment, secure and safe ranges, and clear safety instruction.

Gun safety is a simple but continuous process. Youth must first learn about safe gun handling. Safe handling skills are developed through practice. The most important safety element is attitude. All the safety

knowledge and skills are of little value unless they are used. Being safe means consciously keeping a BB gun under control.

Before handling any gun, a boy must always get permission from his parent or guardian. If this is his first BB gun shooting experience, he should sit down with an adult and discuss under what circumstances the gun can be handled. He must understand that the BB gun is not a toy.

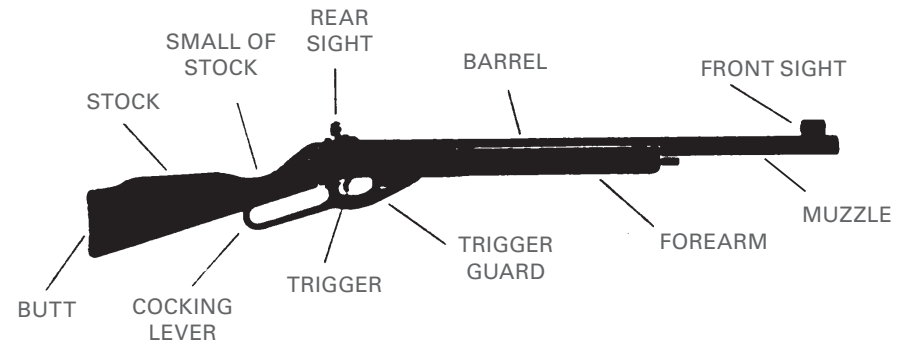

The following basic rules apply to handling a BB gun under any circumstances. Also review any applicable local, state, and federal laws, and be sure to follow them on your range.

1. **Always keep the gun pointed in a safe direction.** This is the primary rule of gun safety. "Safe direction" means that the gun is pointed so that even if it were to go off, it would not cause injury or damage. The key to this rule is to control where the muzzle or front end of the barrel is pointed at all times. Common sense dictates the safest direction depending on circumstances.
2. **Always keep your finger off the trigger until you are ready to shoot.** When holding a gun, rest your finger along the side of the gun or the trigger guard. Until you are actually ready to fire, do not touch the trigger.
3. **Always keep the gun unloaded until ready to use.** When you pick up a gun, carefully point it in a safe direction. Engage the safety, if possible. Then, while keeping your finger off the trigger, open the action and look inside the chamber(s) to make sure it is clear of ammunition. If the gun has a magazine, remove it before opening the action and make sure it is empty. If you do not know how to open the action or inspect the chamber(s), leave the gun alone and get help from someone who does.

4. **Know how to use a gun safely.** Before handling a gun, learn how it operates. Know its basic parts and how to safely open and close the action. Know how to remove ammunition from the gun or magazine.
5. **Be sure the gun is safe to operate.** Just like other tools, guns need regular maintenance to remain in good working order. Regular cleaning and proper storage are part of the gun's general upkeep. If there is any question about a gun's ability to function, then do not use it. Get someone to fix it!
6. **Use only the correct ammunition for the gun.** Only the BB designed for a particular BB gun can be fired safely in that gun. Do not shoot the gun without loading the proper ammunition.
7. **Wear eye protection.** Always wear eye protection. Shooters and instructors should wear approved safety goggles at all BB gun ranges. BBs may ricochet.
8. **Never use alcohol or drugs before or when shooting.** Alcohol or any other substance likely to impair normal mental or physical function must not be used before or while handling or shooting guns.
9. **Don't rely on the safety.** Most guns have a mechanism called a safety that helps to prevent the gun from accidentally firing. However, a safety is a mechanical device, which can—and will—fail. Shooters must be trained that the safety mechanism is not a sure, safe way to prevent a gun from firing. Many accidents have occurred because shooters have relied on the safety mechanism to work.
10. **Wear ear protection.** Although not mandatory for BB gun shooting, ear protection may also be worn. Shots fired from guns are loud and the noise could damage the hearing of some shooters.

11. **Know your target and what is beyond the target.** Be absolutely sure to identify the target beyond any doubt. Equally important, be aware of the area beyond the target. Never fire in a direction where there are people or where any other potential for mishap might exist. Think first. Shoot second.
12. **Store guns so they are not accessible to any unauthorized person.** Deciding where and how to store guns and ammunition depends on several factors, including security and accessibility. Safe and secure storage means that untrained individuals (especially children) are denied access to guns and ammunition.

### Level 1, Requirement 3

*On an approved range, demonstrate to qualified leadership good shooting techniques, including eye dominance, shooting shoulder, breathing, sight alignment, trigger squeeze, and follow-through.*

NOTE: The following activities can be taught in advance at a pre-event meeting or during a separate session.

#### Eye Dominance

Before shooting a gun, the participants should determine which eye is dominant. Just as people are either right- or left-handed, one eye is more dominant than the other. Discovering which eye a shooter favors is important because it could determine on which side the gun is held.

To find which eye is dominant, have participants extend both arms in front of them and form a small hole with their thumbs and index fingers. Instruct them to look at a distant object through the opening and then pull their hands back to their face. The eye that is in line with the object is dominant.



## Shooting Shoulder

It is recommended that a shooter use the shoulder that is on the same side of the body as the dominant eye. If the right eye is dominant, place the firearm against the right shoulder. If the left eye is dominant, use the left shoulder. If the shooter has learned to use the opposite shoulder and eye, it may be more comfortable for him to shoot that way.

## Breathing

When shooting, stop breathing before firing a shot. Breathing causes the body to move and makes it difficult to maintain a steady sight picture. Before firing, relax and get comfortable. Then exhale and stop breathing. This technique will help shooters aim by reducing the body and rifle movement in relation to the target. Do not stop breathing for longer than 8 to 10 seconds while aiming at the target. If you are not able to shoot within that time, stop, take a breath or two, and repeat the process.

## Sight Alignment

The shooter must learn proper sight alignment. This is the relationship of the front and rear sights to the eye. The shooter's dominant eye must be lined up with the front and rear sights, and the sights must be positioned so that the front sight device is aligned properly with the rear sight.

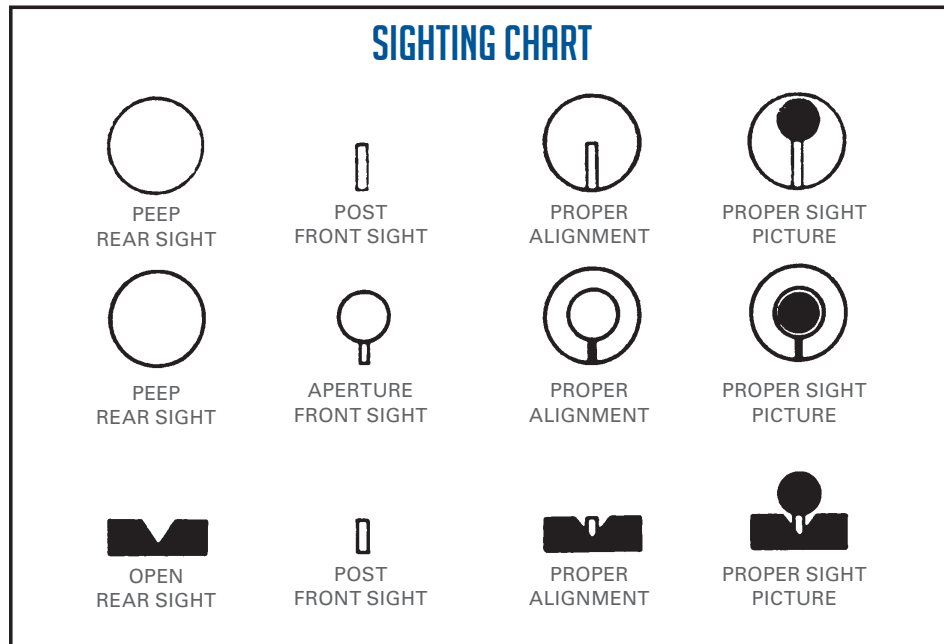

Proper sight alignment is a key to accurate shooting. Any misalignment of the front sight with the rear sight introduces an angular error that is multiplied with distance.

A correct sight picture is obtained by achieving the proper alignment and then putting the aligned sights into their proper relationship with the target.

## Trigger Squeeze

Trigger squeeze is the term used to explain the manner in which pressure is applied to the trigger. Some other terms commonly used are trigger pull, trigger control, trigger press, and trigger movement. While all of these terms are correct, the preferred term is trigger squeeze because it accurately describes the smooth application of pressure required.

When ready to begin squeezing the trigger, the index finger should be located on the trigger so that the trigger is about halfway between the tip of the finger and the first joint.

The trigger must be squeezed straight back in a smooth, continuous manner without disturbing the sight alignment. Once trigger squeeze has begun, keep squeezing smoothly and continuously; do not speed up, slow down, or apply pressure in a start-and-stop manner. Use the same type of pressure that would be used to squeeze a drop of liquid from a medicine dropper—a gradual, steady application of pressure until the drop finally falls. Just as it would be impossible to predict the instant that the drop of liquid will fall, it should be impossible to predict the precise instant that the gun will fire. Each shot should come as a surprise.

For best results, trigger squeeze and sight alignment must be done simultaneously.

## Follow Through

The shooter must also master proper follow-through. Follow-through means to continue to do everything that was being done at the time the shot was fired. In other words, keep aiming until the BB hits the target.

The idea is to prevent any unnecessary movement before the projectile leaves the barrel. Because an air gun takes longer to send a projectile out of the barrel, proper follow-through is particularly important.

## Level 1, Requirement 4

*On an approved range, show how to put away and properly store BB gun shooting equipment after use.*

Work with your range master according to local practices and procedures.

In most cases:

- The BB gun should be unloaded.
- The safety mechanism should be engaged.
- The BB gun should be protected from scratches and scrapes from other guns.
- The BB gun should be locked or otherwise secured in a safe place.

## BB GUN LEVEL 2 REQUIREMENTS

### LEVEL 2: SKILL AND KNOWLEDGE

To earn the Level 2 Skill and Knowledge recognition, Cub Scouts must complete the Level 1 Participation and Knowledge requirements, and do the following:

- Tigers must complete S1–S3 from the Tiger column.
- Wolves and Bears must complete S1–S4 from the Wolf/Bear column.
- Webelos and Arrow of Light Scouts must complete S1–S4 from the Webelos/Arrow of Light column.

	<b>Tiger</b>	<b>Wolf/Bear</b>	<b>Webelos/Arrow of Light</b>
S1	Demonstrate one of the positions associated with shooting BB guns.	Demonstrate one of the positions associated with shooting BB guns.	Demonstrate the prone, bench, and sitting positions associated with shooting BB guns.
S2	On an approved range, fire five BBs at the “TIGER” target. Score your target; then repeat and do your best to improve your score. (Fire a total of 10 BBs.)	On an approved range, fire five BBs at the “CUB SCOUT” target. Score your target; then repeat twice and do your best to improve your score each time. (Fire a total of 15 BBs.)	On an approved range, fire five BBs at the “WEBELOS/AOL” target. Score your target; then repeat three times and do your best to improve your score. (Fire a total of 20 BBs.)
S3	Demonstrate proper range commands, and explain how and when to use them.	Demonstrate proper range commands, and explain how and when to use them.	Demonstrate proper range commands, and explain how and when to use them.
S4		Tell five facts about the history of BB guns.	Tell five facts about the history of BB guns.



# NOTES ON BB GUN LEVEL 2 REQUIREMENTS

## Level 2, Requirement S1: Shooting Positions

Decide with input from your range master the best method and order for accomplishing this requirement.

### Shooting Positions

Proper body position is essential to achieve a good shooting score. When learning any shooting position, these basic steps must be followed:

1. Study the position.
2. Practice the position without a gun. (Learn to put the feet, legs, body, head, and arms in the correct position without holding a gun.)
3. Practice the position with a gun.
4. Align the position properly with the target. Adjust the position so that the gun points naturally at the target.
5. Shoot from the position.



PRONE POSITION



SITTING POSITION

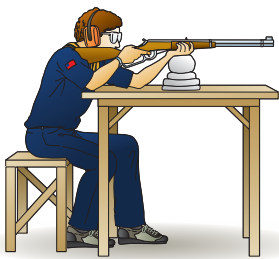

BENCHREST POSITION



FREE-ARM STANDING POSITION

## Level 2, Requirement S2

**Tiger:** On an approved range, fire five BBs at the “TIGER” target. Score your target; then repeat and do your best to improve your score. (Fire a total of 10 BBs.)

**Wolf/Bear:** On an approved range, fire five BBs at the “CUB SCOUT” target. Score your target; then repeat twice and do your best to improve your score each time. (Fire a total of 15 BBs.)

**Webelos/Arrow of Light:** On an approved range, fire five BBs at the “WEBELOS/AOL” target. Score your target; then repeat three times and do your best to improve your score. (Fire a total of 20 BBs.)

Leaders assisting with this requirement should keep in mind the Cub Scout motto, “Do Your Best,” at all times. The goal is for the Cub Scout to improve his technique and, as a result, improve his overall performance. There is NO specific score required for this requirement, only improvement. This may mean five misses the first time, and one hit on the target the second time. While it is clearly desired that he would improve to the point of scoring an actual target, and while it would be good to work to that goal if time allows, the requirement only requires improvement.

Using the designated target for each Cub Scout rank allows boys of all ages the opportunity to reach an appropriate proficiency level. There are three targets for BB guns, as shown below.

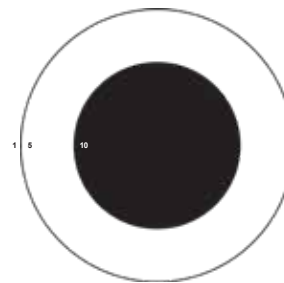

TIGER TARGET

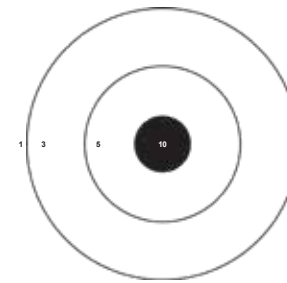

WOLF/BEAR TARGET

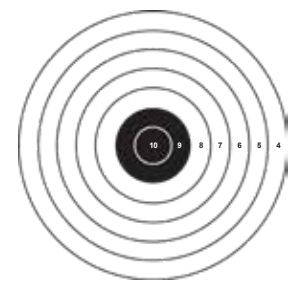

WEBELOS/ARROW OF LIGHT TARGET

These targets are included for reproduction purposes in the poster section of the appendix. Each Cub Scout should use the appropriate target for his rank. When reproducing the targets, choose a paper color that contrasts with the background coloring to make “hits” easier to spot.

## Level 2, Requirement S3

*Demonstrate proper range commands, and explain how and when to use them.*

Safety is critical at your event. The actual commands should be taught, and the Scouts should quiz each other until they acquire a thorough knowledge level. See the appendix for some common range commands, but confirm with your range master the actual commands and their meanings on your range.

 <b>SUGGESTED BB GUN RANGE COMMANDS</b>	
<b>LOAD.</b>	LOAD YOUR BB GUN.
<b>READY ON THE FIRING LINE.</b>	ALL SHOOTERS ARE READY.
<b>COMMENCE FIRING.</b>	YOU MAY FIRE YOUR BB GUN.
<b>CEASE FIRING.</b>	STOP SHOOTING.
<b>CLEAR ALL GUNS.</b>	SHOW YOUR BB GUN IS EMPTY. LAY IT DOWN.

## Level 2, Requirement S4

*Tell five facts about the history of BB guns.*

Using the material in this guide or another source, help the Cub Scouts learn about BB guns and their history.

### A Brief History of BB Guns

In ancient history, blowguns began to appear in many different parts of the world. Although crude, these primitive weapons were very accurate. They were made from bamboo or other hollowed-out woods. A blowgun is a tube into which a hunter blows to shoot a projectile out the other end. This idea was transferred into gun form somewhere in the 1500s. The

bellows gun, invented around 1580, is the earliest known air-powered gun.

A few decades later, the first pneumatic (pump-up) air gun was created in France for King Henry IV. The nobility usually owned these early guns, since they were too expensive for commoners.

In the late 1700s, some units of the Austrian army were equipped with air rifles.

In America, records show that in the 1800s, Lewis and Clark had an air gun for hunting and for impressing the American Indians. The American Indians called it “the smokeless thunder stick.”

In 1885, in the United States, the Markham Air Rifle Company became one of the first companies to sell BB guns. These pneumatic rifles eliminated bullets and used a small pellet the size of a ball bearing, soon to be called a “BB.”

A few years later, a company that sold steel windmills decided to also sell BB rifles. By 1895, this company had stopped producing windmills and made air rifles full-time and changed the company name to Daisy.

Daisy’s guns were mostly made of steel, which improved the gun’s strength and design. The Daisy air rifle became popular very quickly, and within five years Daisy had sold 250,000 BB guns. Soon, Daisy bought out all of its competition.

Daisy also promoted to youth by making special BB guns that related with popular historical characters like Davy Crockett.

In 1984, the Olympic Games featured air guns for the first time.

Today, BB guns are still being produced in both rifle and pistol forms and are very popular among all age groups.

# ARCHERY LEVEL 1 REQUIREMENTS

## LEVEL 1: PARTICIPATION AND KNOWLEDGE (ALL RANKS)

1. Demonstrate how to follow archery range safety rules and whistle commands.
2. Identify and name a recurve bow and/or compound bow.
3. Explain and demonstrate how to apply and use arm guards, finger tabs, and quivers.
4. On an approved range, demonstrate how to safely and effectively shoot a bow and arrow, including how to establish a correct stance, nock the arrow, hook and grip the bow, raise the bow, draw, anchor, hold, aim, and release/follow through.
5. On an approved range, demonstrate how to safely retrieve arrows after the range is clear and the command to retrieve arrows has been provided.

## NOTES ON ARCHERY LEVEL 1, REQUIREMENT 1

This requirement may be taught in advance of the shooting experience at a pre-event meeting or additional program station in a camp setting. **Be sure to use the actual rules and commands or whistle codes your range will use!**

## ARCHERY RANGE RULES AND COMMANDS

### ARCHERY RANGE RULES

1. Always walk on the range.
2. Keep your arrows in your quiver until you are told to shoot.
3. Only release the bow string when an arrow is nocked and safely pointed toward the target.
4. Leave dropped arrows on the ground until instructed to retrieve them.

**If there is an emergency on the range, immediately tell the instructor.**

### WHISTLE COMMANDS

- 2 WHISTLE BLASTS** = Go to the line.
- 1 WHISTLE BLAST** = Shoot.
- 3 WHISTLE BLASTS** = Retrieve arrows.
- 5 OR MORE WHISTLE BLASTS** = Emergency. Immediately stop shooting, return bows to the rack, and go behind the waiting line.

(From USAA Archery Certification Course – Level 1 manual. Used with permission.)

### Level 1, Requirement 1:

*Demonstrate how to follow archery range safety rules and whistle commands.*

Tigers with their adult partners, and Wolf, Bear, and Webelos Scouts should learn these simple safety rules. When training youth to shoot, be sure to have proper equipment, secure and safe ranges, and clear safety instruction.

### Safety Rules for Archers

1. Observe all state and local laws on using a bow and arrow.
2. Shoot only with proper range supervision.
3. Always check your equipment before shooting. Break and discard all cracked or fractured arrows.
4. Be sure to include all of the safety guidelines and the proper whistle codes.
5. Bows and arrows should be used only in places set aside for their use.
6. Always keep your arrows pointed down or toward the target.

7. Only release an arrow when you can see its full clear path to the target.
8. Shoot only at the target in front of you.
9. Keep the arrows in the quiver until everyone is on or behind the shooting line and the range master has indicated that you may begin shooting.
10. Archers stand with both feet behind the line.
11. Stop shooting immediately upon signal from the range master or if anyone crosses in front of the shooting line or in front of or behind the targets.
12. Use only arrows that have been measured for your proper draw length. Arrows that are too short may cause personal injury or damage to the bow and arrow.
13. Always wear an arm guard and finger tab or glove.
14. Always practice courtesy and good sportsmanship.
15. Always walk, never run, when on the archery range or while carrying arrows.
16. On a target range, leave the bow standing against the target face while you are looking for lost arrows.
17. Stay on marked paths. Travel the direction in which the targets are marked.

### Safety Rules for Range Masters

1. **Know** where arrows will go if the target is missed and to ensure a safety zone is in place.
2. **Lock, secure, and affix signs** to all access gates and entranceways downrange of the Shooting Line to inform people of the activity.
3. **Communicate** with range officers and other camp personnel regarding when and where archery activities will take place.
4. **Avoid shooting into the sun.**

5. **Know how many arrows the archers have** before shooting to be sure they are all retrieved.
6. **Clear the range** of any potential tripping hazards.

*(From USAA Archery Certification Course – Level 1 manual. Used with permission.)*

### Level 1, Requirement 2:

*Identify and name a recurve bow and/or compound bow.*

The two bows most commonly used by Cub Scouts are

- **Recurve:** Recurve bows are the traditional bow for learners. It allows the archer to better learn proper finger tension. Modern recurve bows are either made entirely of fiberglass, or are a composite of wood and fiberglass. Both options are satisfactory for beginning instruction.
- **Compound:** Compound bows are generally harder to master, but they will produce more consistent results. The pulley system provides a mechanical advantage to assist where strength or stamina is an issue.

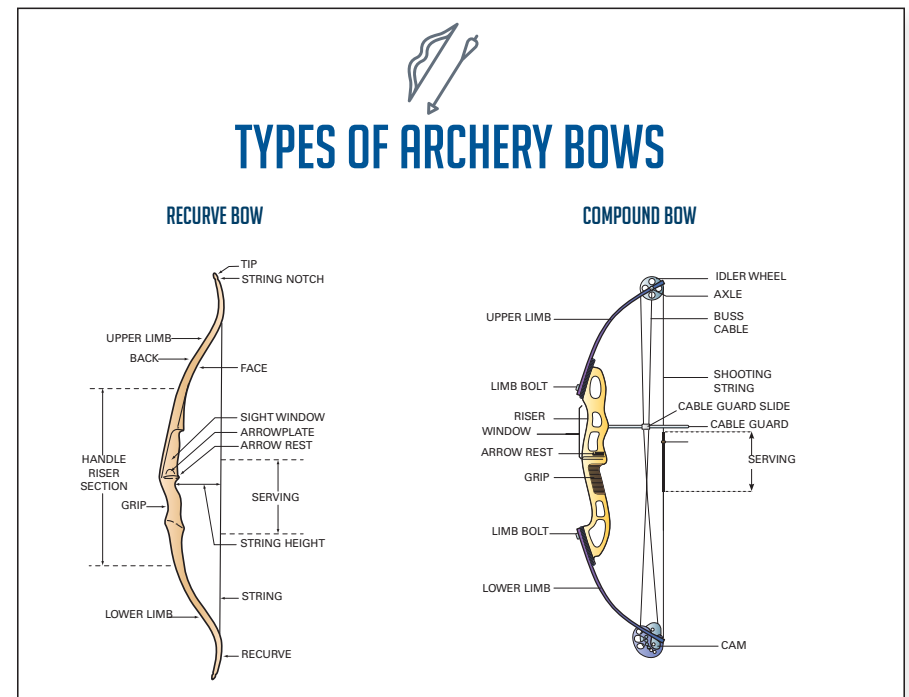

All archers should be able to identify a recurve bow and compound bow. If your range uses only one type, obtain an example of the other for identification purposes to meet the requirement.

### Level 1, Requirement 3:

*Explain and demonstrate how to apply and use arm guards, finger tabs, and quivers.*

Use the safety equipment available at your range, and demonstrate how to wear and adjust it properly. This should include arm guards, finger tabs, arrows, and quivers. Depending on the size of your shooters, you may need to adjust which equipment can be used safely. Be sure to cover loose and oversized shirts, jackets, or other items that may constitute a hazard when shooting arrows.



### Arm Guards

An arm guard is a piece of still material, usually leather or nylon, that attaches to the inside of the forearm of the archer's bow arm to protect it from the bowstring upon release. It also holds down jacket and shirt sleeves so they don't interfere with the bowstring's travel. The larger part goes toward the elbow. A right-handed archer should wear the guard on his left arm, a left-handed archer on his right arm.

#### Care of Arm Guards

Arm guards should have laces or elastic replaced when needed. Arm guards should be kept in labeled boxes. All leather goods will last longer if stored in a cool, dry place and occasionally cleaned with saddle soap.

**Every shooter must use an arm guard and finger protector.**

### Finger Tabs

Finger tabs are preferable to gloves for group instruction because they present fewer fitting problems. Made of smooth leather, finger tabs absorb the friction of the bowstring across the fingertips. Without them, painful blisters can develop. Many designs are available, but for beginners the simplest and most inexpensive type is satisfactory.

### Quivers

For the young beginner, having a quiver to use when returning arrows from the target to the shooting line will improve safety procedures.

### Level 1, Requirement 4:

*On an approved range, demonstrate how to safely and effectively shoot a bow and arrow, including how to establish a correct stance, nock the arrow, hook and grip the bow, raise the bow, draw, anchor, hold, aim, and release/follow through.*

#### Step 1: STANCE

Stance is the correct foot position of the archer. The goal is to provide a solid foundation for the shot. An archer is most stable in an open stance.

1. Stand with both feet behind the shooting line.
2. Feet should be shoulder-width apart.
3. Move the foot closest to the target back about 3 inches.
4. Turn the toes of both feet toward the target about 30 degrees.

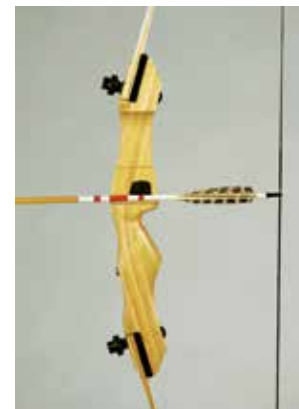

#### Step 2: Nock the Arrow

To nock an arrow is to securely place the arrow onto a bowstring. When the arrow is securely placed on the bowstring, the archer feels and/or hears the arrow "snap" into place.

1. Grasp the arrow below the nock.
2. Bring the arrow up and over the bow and place it on the arrow rest.



3. Spin the arrow so the index vane (usually a different color) points away from the riser and toward the archer's body.
4. Push the nock into place on the bowstring directly below the nocking point.



### Step 3: Hook and Grip

Archers touch the bow in only two places: the bowstring where they “hook” it, and at the grip where they “grip” it. *Hook* is when an archer curls three fingers around the bowstring directly beneath the arrow. The *grip* on a bow is where the archer places his or her hand on the bow.

1. Curl the bowstring with the fingertips of the index, middle, and ring fingers under the arrow.
2. Pull the bowstring back enough to apply a small amount of tension.
3. Center the meaty part of the thumb on the back of the bow grip.
4. Point the thumb toward the target and angle your knuckles 45 degrees. Check to be sure the grip is relaxed.

### Step 4: Raise the Bow

This step gives the archer the opportunity to confirm that all previous steps have been completed before proceeding. Once that is done, do the following:

1. Turn the head toward the target.
2. Rotate the elbow of the bow arm away from the bowstring.
3. Lift both arms to shoulder height.
4. Extend the bow arm fully, keeping the bow vertical.

The archer raises the bow in preparation for drawing back the bowstring. This gives the archer a sense of direction by knowing where the bow is in relation to the target. While raising the bow, it is important to keep the rest of the body still.

### Step 5: Draw

Pull the bowstring back toward the face. The draw should be seamless and smooth.

### Step 6: Anchor

The archer should pull the bowstring back to a consistent anchor point every time to maintain accuracy. For beginning archers, the corner of the mouth is the preferred anchor point.

1. Settle the index finger of the draw hand into the corner of the mouth.
2. Keep the draw hand relaxed and up against the face.

### Step 7: Hold

Move the draw arm elbow slightly behind the arrow to brace the draw weight of the bow. The tension of holding the bow is now transferred from the shoulder and arm muscles to the back muscles.



### Step 8: Aim

Aim is lining up the arrow to the target. Simply put, the arrow will go where it is pointed. The goal is to focus equally on the target and the arrow point.

1. Place the point of the arrow on the intended target area.
2. The eye focus is equally on the arrow point and the target.

### Step 9: Release/Follow Through

Release occurs when the archer relaxes the tips of the fingers that are hooking the bowstring, allowing the bowstring to push the fingers out of the way. Follow-through is the finish position.

**Refer to the Archery Shooting Form poster, found on page 41 of the appendix.**

1. Relax the fingertips to allow the bowstring to push the fingers out of the way.
2. Keep the bow arm up.
3. Finish the shot by allowing the draw hand to fall between the ear and the shoulder.

### Level 1, Requirement 5:

*On an approved range, demonstrate how to safely retrieve arrows after the range is clear and the command to retrieve arrows has been provided.*



### Retrieve Arrows

After all archers have shot their allotment of arrows (usually around six, if time permits), demonstrate and explain the proper methods to retrieve arrows from the target and ground.

First, before any archer goes to retrieve any arrows, permission must be granted by the range officer. The range officer will observe the archers and indicate when all archers have completed shooting and it is safe to retrieve arrows.

1. Follow the proper commands to move to the target line. Archers should walk slowly to the target and watch for arrows on the ground.
2. Remove arrows by standing to the side of the target and brace it with the side of the body. Place one hand on the target at the base of the arrow.
3. Grasp the arrow near the target and pull firmly and slowly straight back toward the shooting line.
4. Place the arrow on the ground.
5. Remove any others and place them on the ground.
6. After all the arrows have been removed, pick up the arrows from the ground. Cover the points with one hand and grasp the arrows near the fletching with the other hand. An arrow buried under the grass should be withdrawn point first and be completely clear of the grass before the arrow is lifted.
7. Walk back to the shooting line and place the arrows into the ground quiver.
8. Move off the range, or prepare to resume shooting, as commanded.

# ARCHERY LEVEL 2 REQUIREMENTS

## LEVEL 2: SKILL AND KNOWLEDGE

To earn the Level 2 Skill and Knowledge recognition, Cub Scouts must complete the Level 1 Participation and Knowledge requirements, and do the following:

- Tigers must complete S1–S3 from the Tiger column.
- Wolves must complete S1–S4 from the Wolf column.
- Bears must complete S1–S4 from the Bear column.
- Webelos and Arrow of Light Scouts must complete S1–S4 from the Webelos/Arrow of Light column.

	<b>Tiger</b>	<b>Wolf</b>	<b>Bear</b>	<b>Webelos/Arrow of Light</b>
S1	Identify three parts of the arrow and three major parts of the bow you will be shooting.	Identify three parts of the arrow and four major parts of the bow you will be shooting.	Identify four parts of the arrow and five major parts of the bow you will be shooting.	Identify five parts of the arrow and six major parts of the bow you will be shooting.
S2	Shoot three arrows at a target on an approved range; then repeat and do your best to improve your score. (Shoot a total of six arrows.)	Shoot five arrows at a target on an approved range; then repeat and do your best to improve your score. (Shoot a total of 10 arrows.)	Shoot five arrows at a target on an approved range; then repeat twice and do your best to improve your score each time. (Shoot a total of 15 arrows.)	Shoot five arrows at a target on an approved range; then repeat three times and do your best to improve your score each time. (Shoot a total of 20 arrows.)
S3	Demonstrate proper range commands, and explain how and when to use them.	Demonstrate proper range commands, and explain how and when to use them.	Demonstrate proper range commands, and explain how and when to use them.	Demonstrate proper range commands, and explain how and when to use them.
S4		Tell five facts about archery in history or literature.	Tell five facts about archery in history or literature.	Tell five facts about archery in history or literature.

# NOTES ON ARCHERY LEVEL 2 REQUIREMENTS

## Level 2, Requirement S1: Parts of the Bow and Arrow

Review the parts of a bow and arrow with Cub Scouts. Determine that each Cub Scout has identified the number of parts needed to meet the requirement for his rank.

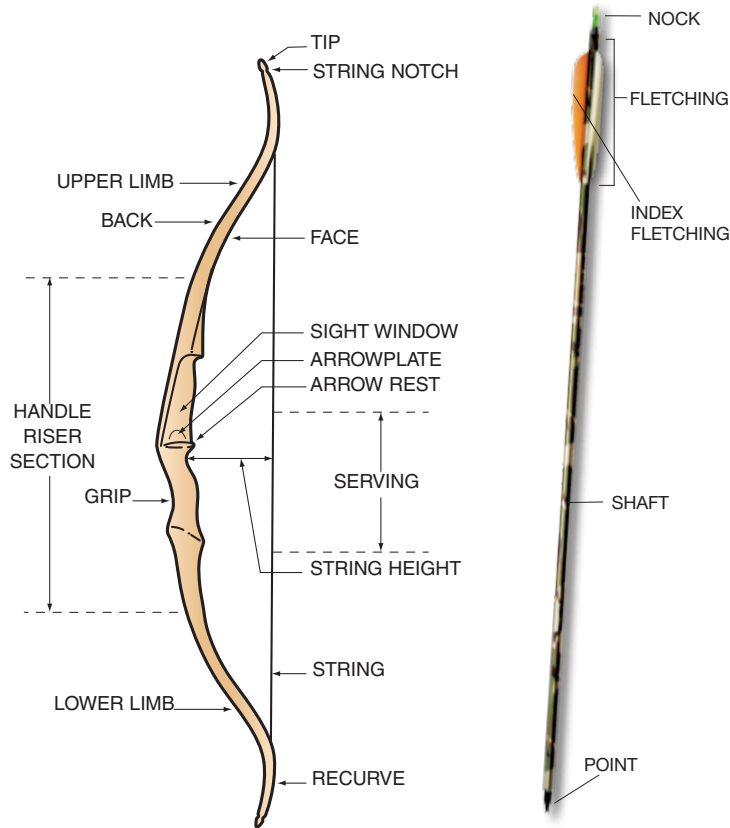

**Arrow:** A shaft made of carbon, aluminum, wood, fiberglass, or composite materials with a point on one end and a nock on the other end. Fletching, which can be either feathers or plastic vanes, are located on the arrow near the nock end.

**Field point:** Similar to a target point and has a distinct shoulder, so that missed outdoor shots are easier to remove from obstacles such as tree stumps

**Fletching:** The stabilizing feathers or vanes of an arrow

**Index fletch or vane:** A different-colored fletch or vane used to indicate proper arrow positioning in relation to the bowstring or bow

**Nock:** The plastic attachment or grooved notch at the end of an arrow used to attach the arrow to the bowstring

**Shaft:** The main structural element of an arrow

**Target Point:** Attaches to the front end of an arrow and penetrates the target

## Level 2, Requirement S2

**Tiger:** Shoot three arrows at a target on an approved range; then repeat and do your best to improve your score. (Shoot a total of six arrows.)

**Wolf:** Shoot five arrows at a target on an approved range; then repeat and do your best to improve your score. (Shoot a total of 10 arrows.)

**Bear:** Shoot five arrows at a target on an approved range; then repeat twice and do your best to improve your score each time. (Shoot a total of 15 arrows.)

**Webelos/Arrow of Light:** Shoot five arrows at a target on an approved range; then repeat three times and do your best to improve your score each time. (Shoot a total of 20 arrows.)

**Cub Scout-level target scoring should be kept simple. For Tigers, it may be just hitting the hay bale or a large piece of paper on the bale. As the archers progress in skill, move to more structured scoring methods.**

Leaders assisting with this requirement should keep in mind the Cub Scout motto, "Do Your Best," at all times. The goal is for the Cub Scout to improve his technique and, as a result, improve his overall performance. There is NO specific score required for this requirement, only improvement. This may mean five misses the first time, and one hit on a hay bale the second time. While it is clearly desired that he would improve to the point of scoring an actual target and, if there is adequate time, it would be good to work to that goal, the requirement only requires improvement.

## Level 2, Requirement S3

*Demonstrate proper range commands, and explain how and when to use them.*

This requirement is to be completed once for the level 1 award, and again for the level 2 award, according to the commands and rules practiced on your approved range.

With assistance from your range master, determine which range commands will be used. This may mean special archery whistle codes, or just a version of the BB gun range commands, depending on your location. This requirement could be partially accomplished off the firing line for instruction and then demonstrated on the firing line.

## Level 2, Requirement S4

*Tell five facts about archery in history or literature.*

Using the material in this guide or another source, help the Cub Scouts learn about archery in history or literature.

### A Brief History of Archery

The advancement of civilization was enhanced by the use and discovery of bows and arrows. The bow and arrow provided a much safer way to hunt and made life easier.

Generally it is thought the spear was the predecessor to the bow. Spearheads have been discovered from many thousands of years ago.

A recognizable bow was discovered dating back to 6000 B.C. that was made from yew or elm.

Egyptians, somewhere around 3500 B.C. to 2800 B.C., are considered the first to use the bow in battle, which gave them superiority over their enemies. This bow was known as a composite bow.

Assyrians developed a shorter recurve bow that provided more power and easier handling around 1500 B.C. Crossbows were also used in ancient China, but not until many years later.

Around 1200 B.C., a famous Egyptian pharaoh named Ramses II gave archery another boost by putting archers on chariots. This mobility allowed the Egyptians to defeat the Hittite army.

Through the course of history the wooden bow was made longer. The British were famous for improving on the bow, which eventually became known as the British longbow. The most famous battle of the longbow was the battle of Crécy in 1346. In 1500, crossbows were banned in England to promote the use of the longbow. In 1595, the army was ordered to replace all bows with muskets. Still, archery has remained a popular sport in England.

Around 1000 A.D., bow and arrow technology swept the Americas. As seen through archeological studies, its use was adopted by most prehistoric Native Americans.

In 1879 the National Archery Association was founded. The first national tournament was held in White Stocking Park, Chicago, Illinois, that same year. The first archery club in the U.S., the United Bowmen of Philadelphia, was founded in 1928.

In 1900, archery became an Olympic sport, but it was dropped after 1920 because the rules could not be standardized. In 1931, the Fédération Internationale de Tir à l'Arc (FITA) was founded in Paris, and it standardized the rules for international competition. Archery returned to the Olympics in 1972 and is still part of the Olympic program. USA Archery is the sanctioning body in the United States for archery events.





# SLINGSHOT LEVEL 1 REQUIREMENTS

## LEVEL 1: PARTICIPATION AND KNOWLEDGE (ALL RANKS)

1. On an approved range, demonstrate to qualified leadership good shooting techniques, including eye dominance, breathing, sight alignment, and follow-through.
2. On an approved range, explain the parts of a slingshot and demonstrate how to properly use them.
3. Explain the different types of ammunition that may be used with a slingshot and those that may not be used.
4. Explain the different types of targets that may be used with a slingshot and those that may not be used.

## NOTES ON SLINGSHOT LEVEL 1 REQUIREMENTS

**CAUTION: Slingshot bands contain natural rubber latex. Those who are allergic to rubber latex should not use slingshots. Allergic reactions such as skin rashes, hives, or nasal, eye, or sinus symptoms may occur.**

**Slingshot ranges, equipment, and safe practices must follow the guidelines spelled out in the *National Shooting Sports Manual*. Generally, the same rules apply for this activity that would apply for BB gun shooting.**

The preferred slingshot for Cub Scouts has a wrist brace so the shooter's hand doesn't become weak from having to hold the frame tightly.

Using slingshots is an affordable, fun activity in council-sponsored camps. Boys love to shoot slingshots, and many have not had previous experience with them.

Although exciting and fun, slingshots are not toys. Boys must understand that they must follow the rules when shooting slingshots or they will not be allowed to participate.

Shooting items from slingshots can be dangerous. For these activities, follow the same safety guidelines as used for BB shooting. Always shoot at a range such as an archery or BB gun range.

### Level 1, Requirement 1:

*On an approved range, demonstrate to qualified leadership good shooting techniques, including eye dominance, breathing, sight alignment, and follow-through.*

#### Good Shooting Techniques

(Instructions are for right-handed shooters. Reverse instructions for left-handed shooters where applicable.)

1. A range master must be present and there must be a one-to-one adult-to-boy ratio.
2. Use a safe shooting range such as a BB gun range or archery range.
3. Wear protective eyeglasses or goggles.
4. Do not pick up a slingshot until told to do so.
5. Never shoot at anything if you cannot see what is behind it.
6. Do not use a slingshot with a power band damaged by age or weather.
7. Never shoot up into the air.

8. Never cross the firing line when shooting.
9. Point your left foot and shoulder directly at the target with the body turned to the right. Turn the head directly toward the target.
10. Center the ammo in the middle of the leather pouch. Hold the handle firmly in the left hand and pinch the ends of the leather pouch together with the thumb and index finger of the right hand, encompassing the ammo.
11. Hold the left arm out straight and firm. Draw the right hand back level with the right cheek—NEVERTO THE EYE—while holding the leather pouch securely between the thumb and index finger of the right hand.
12. Aim and release the leather ammo pouch to shoot.
13. Always practice courtesy and good sportsmanship!

### Eye Dominance

Before shooting a slingshot, the participants should determine which eye is dominant. Just as people are either right- or left-handed, one eye is dominant over the other. Discovering which eye a shooter favors is important because it could determine on which side the slingshot is held.

To find which eye is dominant, have participants extend both arms in front of them and form a small triangle with their thumbs and index fingers. Instruct them to look at a distant object through the opening and then pull their hands back to their face. The eye that is in line with the object is dominant. (See page 30 in the appendix.)

### Breathing

When shooting, stop breathing before firing a shot. Breathing causes the body to move and makes it difficult to maintain a steady sight picture. Before firing, relax and get comfortable. Then exhale and stop breathing. This technique will help shooters aim by reducing the body and slingshot movement in relation to the target. Do not stop breathing for longer than 8 to 10 seconds while aiming at the target. If you are not able to shoot within that time, stop, take a breath or two, and repeat the process. The pouch of the slingshots should be pulled all the way back to your cheek and released as you breath out.

### Aiming: Sight Alignment

To aim a slingshot, hold it horizontally and aim with the upper fork end. To shoot correctly, the ammo will need to be centered inside the slingshot pouch. You will also need to make sure that the slingshot handle is parallel to the ground and that the fork is 90 degrees to the upright position.

### Follow Through

The shooter must also master proper follow-through. Follow-through means continuing to do everything that was being done at the time the shot was fired. In other words, maintaining aim until the ammunition shot from the pouch of the slingshot hits the target. The idea is to prevent any unnecessary movement before the projectile leaves the pouch.

See the Slingshot Range Rules poster on page 44 of the appendix.

### Level 1, Requirement 2:

*On an approved range, explain the parts of a slingshot and demonstrate how to properly use them.*

### Slingshot Parts

**Hand grip and forks.** These form the basic slingshot design. The hand grip can be customized as needed. The forks are made of sturdy metal or other material which will not bend.

**Wrist brace.** The wrist brace attaches to the basic slingshot and is used to stabilize the shooting platform and provide more leverage for the shooter to apply power.

**Bands.** Bands are usually made of latex surgical tubing, which stretches to propel ammunition.

**Pouch.** The pouch holds ammunition, usually made of leather or other sturdy material.



### Level 1, Requirement 3:

*Explain the different types of ammunition that may be used with a slingshot and those that may not be used.*

Items shot from slingshots are considered ammunition. Generally people use small rocks or pebbles; however, this is not appropriate for Cub Scouts. Instead, use softer ammunition such as pinto beans or dog food. Ammunition such as ball bearings may not be used.

### Level 1, Requirement 4:

*Explain the different types of targets that may be used with a slingshot and those that may not be used.*

#### Targets

Targets for slingshots can be made from a variety of materials, including paper, cans, plastic bottles, and balloons. Paper targets can be homemade or purchased. Cans are excellent as they make a great sound when hit. Cans, plastic bottles, and balloons can be hung from strings or attached to netting. Remember to recycle when finished.

You can also practice using a slingshot on a bull's-eye target about 2 inches in diameter and with the target 10 feet away; then move the target out to 25 yards.

## NOTES ON SLINGSHOT LEVEL 2 REQUIREMENTS

### Level 2, Requirement S1

**Tiger:** *On an approved range, shoot three shots at a target; then repeat and do your best to improve your score. (Shoot a total of six shots.)*

**Wolf:** *On an approved range, shoot five shots at a target; then repeat and do your best to improve your score. (Shoot a total of 10 shots.)*

**Bear:** *On an approved range, shoot five shots at a target; then repeat twice and do your best to improve your score each time. (Shoot a total of 15 shots.)*

**Webelos/Arrow of Light:** *On an approved range, shoot five shots at a target; then repeat three times and do your best to improve your score each time. (Shoot a total of 20 shots.)*

Leaders assisting with this requirement should keep in mind the Cub Scout motto, "Do Your Best," at all times. The goal is for the Cub Scout to improve his technique and, as a result, improve his overall performance. There is NO specific score required for this requirement, only improvement. This may mean five misses the first time, and one hit on a target the second time. While it is clearly desired that he would improve to the point of scoring an actual target and, if there is adequate time, it would be good to work to that goal, the requirement only requires improvement.



## Level 2, Requirement S2

*Demonstrate proper range commands and explain how and when to use them.*

Generally, these will be the same as BB gun range commands. Consult with your range master to determine existing range commands, or develop the actual commands used on the range.



### GENERAL SLINGSHOT RANGE COMMANDS

<b>LOAD.</b>	LOAD YOUR SLINGSHOT.
<b>READY ON THE FIRING LINE.</b>	ALL SHOOTERS ARE READY.
<b>COMMENCE FIRING.</b>	YOU MAY FIRE YOUR SLINGSHOT.
<b>CEASE FIRING.</b>	STOP SHOOTING.

## Level 2, Requirement S3

*On an approved range, try shooting with your non-dominant hand.*

Firing a slingshot requires strength in the hand holding the grip and strength in the hand holding the pouch. Both hands play a role in proper aiming of the slingshot. You may find that switching hands helps with coordination or accuracy and may even help you determine which is your dominant eye. This requirement will be completed once an honest attempt has been made; there is no measurement for accuracy or scoring.

## APPENDIX 1: POSTERS

- 29 General Shooting Range Rules
- 30 Eye Dominance
- 31 BB Gun Sighting Chart
- 32 Parts of a BB Gun
- 33 If You Find a Gun
- 34 Suggested BB Gun Range Commands
- 35 Suggested BB Gun Safety Rules
- 36 BB Gun Shooting Positions
- 37 BB Gun Targets
- 40 Archery Range Rules and Commands
- 41 Archery Shooting Form
- 42 Types of Archery Bows
- 43 General Slingshot Range Commands
- 44 General Slingshot Range Rules
- 45 Slingshot Safety Rules
- 46 Parts of a Slingshot
- 47 Cub Scout Shooting Sports Tracking Template





# GENERAL SHOOTING RANGE RULES

1. This range may be opened only by a qualified BSA-certified range master.
2. All commands issued by the range master must be obeyed immediately.
3. Stay behind the firing line. Do not straddle the firing line.
4. Do not pick up a gun, bow, arrow, or slingshot unless told to by the range master.
5. Absolutely no running on the range.
6. No horseplay or unnecessary talking on the range.
7. If in doubt about the rules, ask your leader or range master for advice or help.



# EYE DOMINANCE

Eye dominance is the unconscious preference to use one eye rather than the other to aim. The dominant eye often corresponds with the archer's dominant hand, but not always. There are a number of people who are "cross dominant," meaning they may be right-hand dominant and left-eye dominant, or vice versa.

It is important to understand how to determine eye dominance in the event a shooter or archer is struggling to aim or hit the target consistently. Eye dominance needs to be addressed when a shooter or archer is shooting with their dominant hand, but trying to aim with their opposite dominant eye. They may try to line up their dominant eye to the target by tipping their head over the bow or gun, causing their shots to be consistently left or right of center on the target.

---

**Important Note: It is not necessary to make a Cub Scout who is cross dominant shoot with his non-dominant hand. The shooter may simply choose to continue shooting with the dominant hand and cover or close the non-dominant eye.**

## To Find the Dominant Eye

To find which eye is dominant, have participants extend both arms in front of them and form a small hole with their thumbs and index fingers. Instruct them to look at a distant object through the opening and then pull their hands back to their face. The eye that is in line with the object is dominant.





# BB GUN SIGHTING CHART

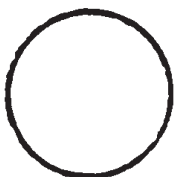

PEEP  
REAR SIGHT



POST  
FRONT SIGHT

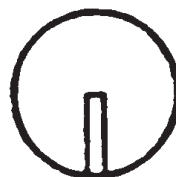

PROPER  
ALIGNMENT

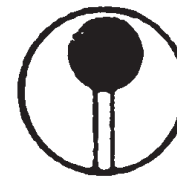

PROPER SIGHT  
PICTURE

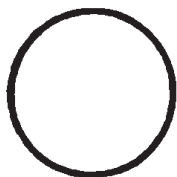

PEEP  
REAR SIGHT



APERTURE  
FRONT SIGHT



PROPER  
ALIGNMENT

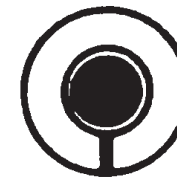

PROPER SIGHT  
PICTURE



OPEN  
REAR SIGHT



POST  
FRONT SIGHT



PROPER  
ALIGNMENT



PROPER SIGHT  
PICTURE



# PARTS OF A BB GUN

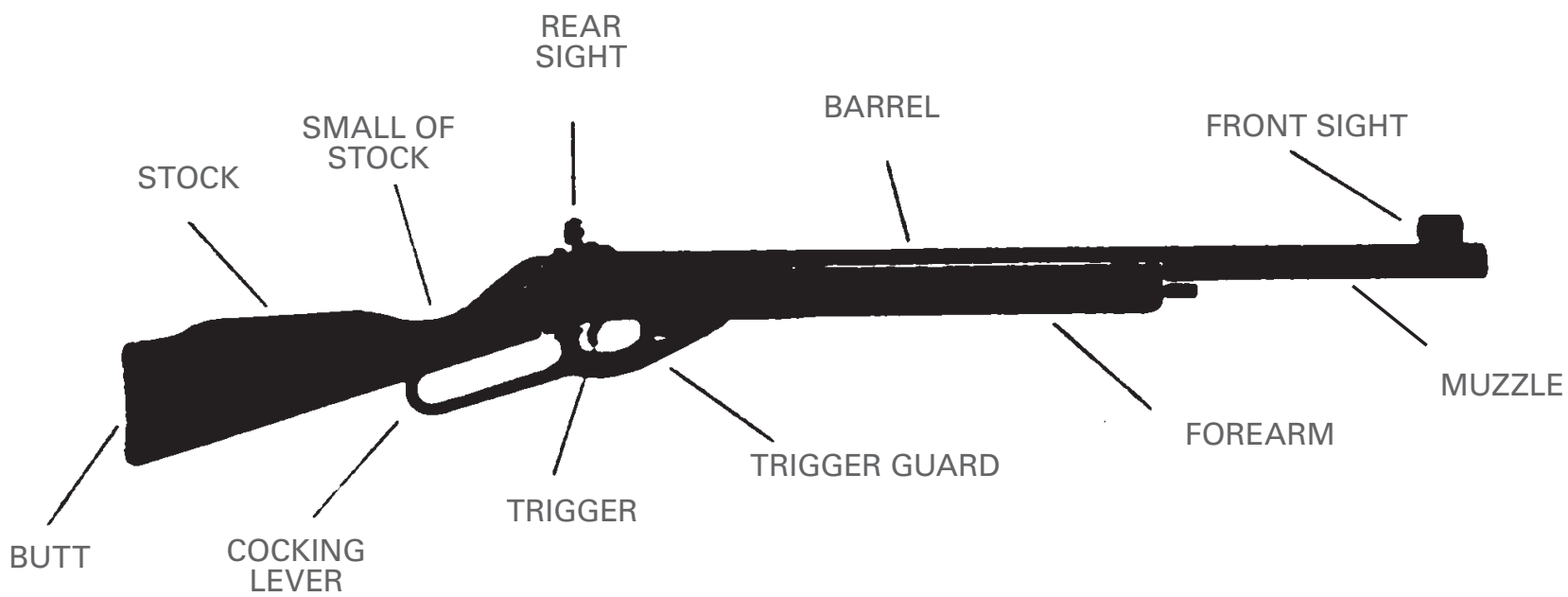



## IF YOU FIND A GUN

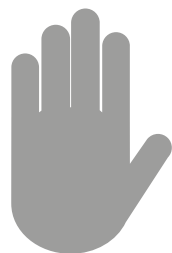

**STOP!**



**LEAVE THE AREA!**



**DON'T TOUCH!**

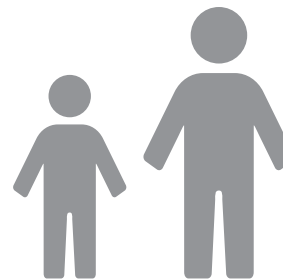

**TELL AN ADULT!**





# SUGGESTED BB GUN RANGE COMMANDS

<b>LOAD.</b>	LOAD YOUR BB GUN.
<b>READY ON THE FIRING LINE.</b>	ALL SHOOTERS ARE READY.
<b>COMMENCE FIRING.</b>	YOU MAY FIRE YOUR BB GUN.
<b>CEASE FIRING.</b>	STOP SHOOTING.
<b>CLEAR ALL GUNS.</b>	SHOW YOUR BB GUN IS EMPTY. LAY IT DOWN.



# SUGGESTED BB GUN SAFETY RULES

1. Always keep the gun pointed in a safe direction.
2. Always keep your finger off the trigger until you are ready to shoot.
3. Always keep the gun unloaded until ready to use.
4. Know how to use a gun safely.
5. Be sure the gun is safe to operate.
6. Use only the correct ammunition for the gun.



# BB GUN SHOOTING POSITIONS



PRONE POSITION



SITTING POSITION

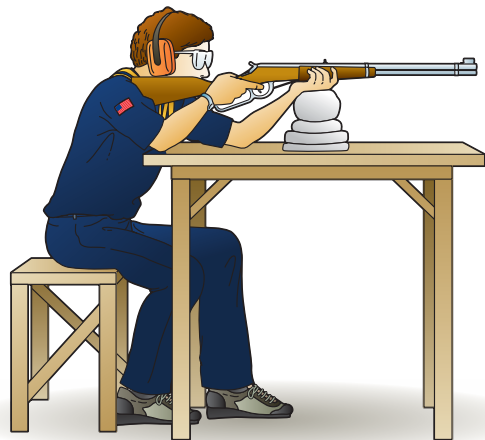

BENCHREST POSITION

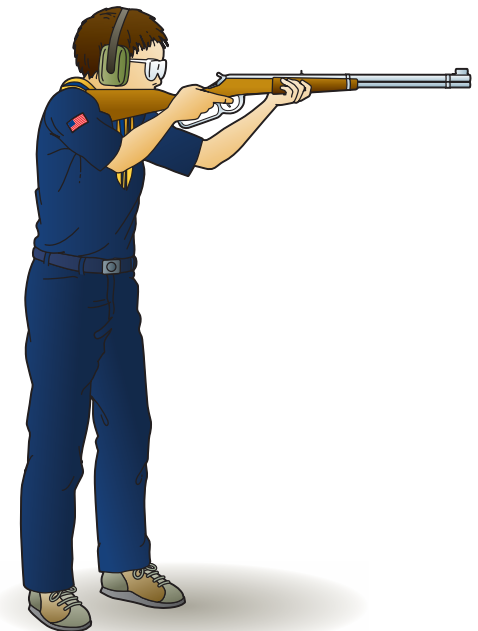

FREE-ARM STANDING  
POSITION

# TIGER TARGET

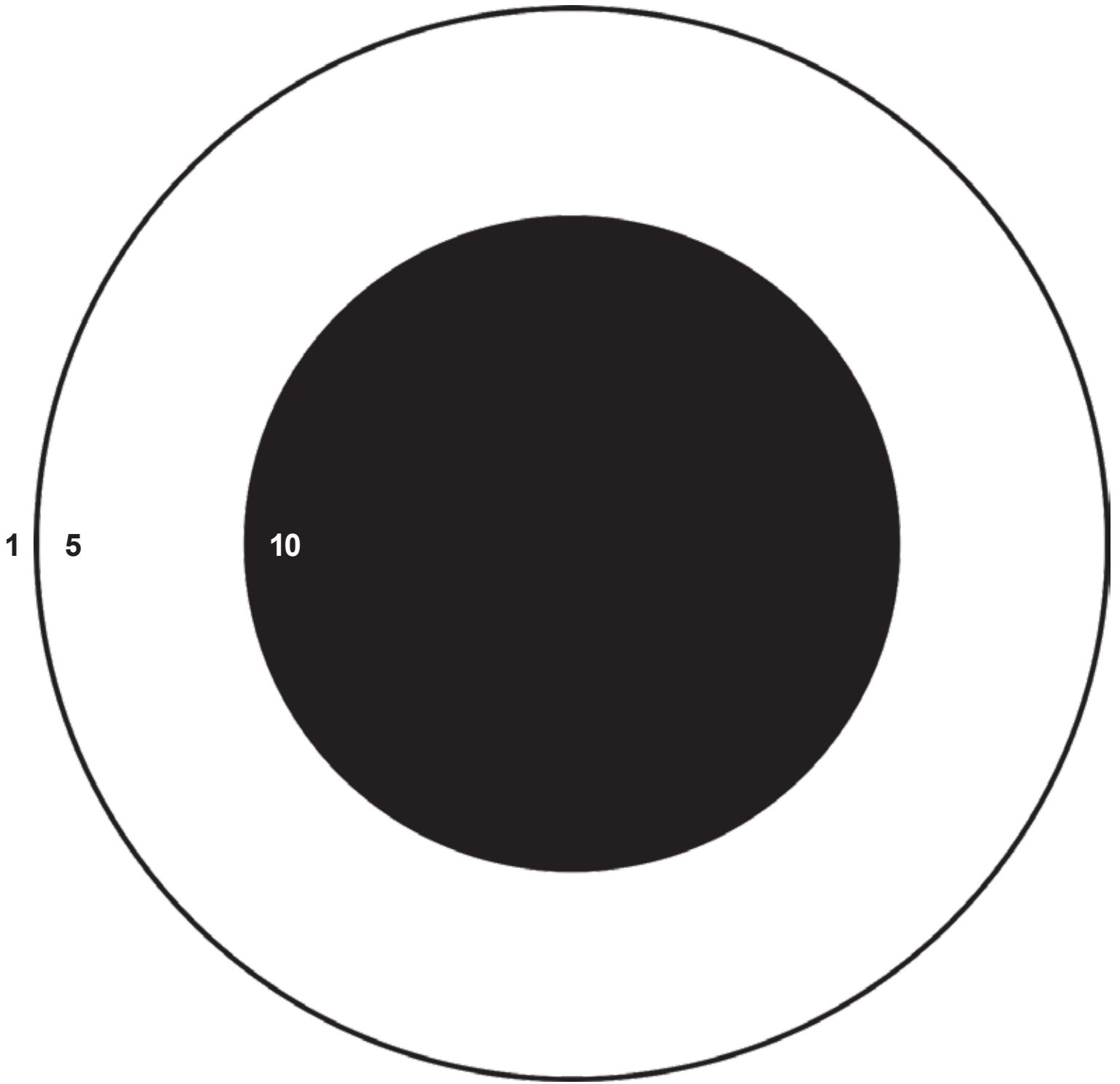

\_\_\_\_\_ Name

\_\_\_\_/\_\_\_\_/\_\_\_\_ Date

\_\_\_\_\_ Score

# WOLF/BEAR TARGET

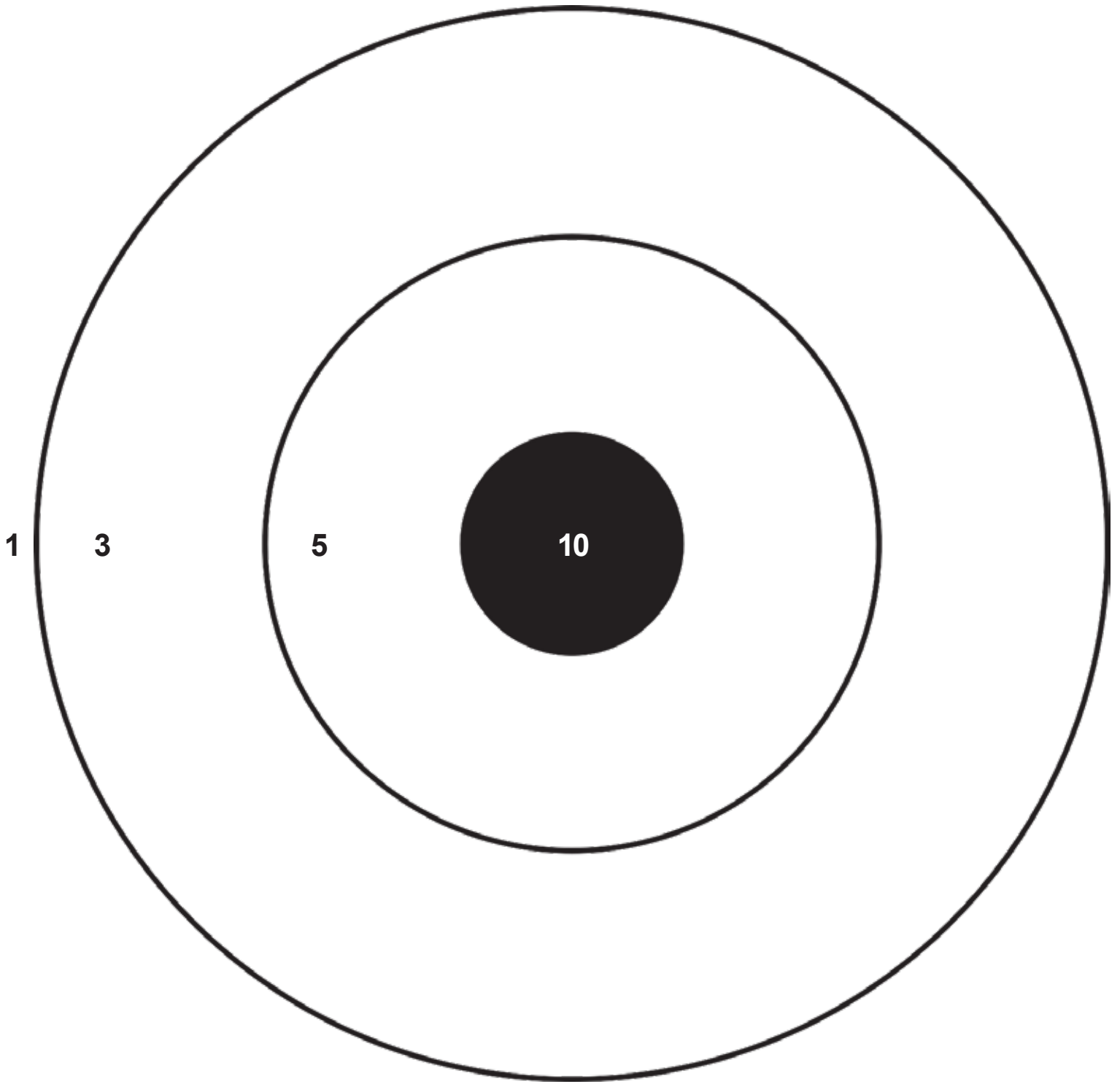

\_\_\_\_\_ Name

\_\_\_\_/\_\_\_\_/\_\_\_\_ Date

\_\_\_\_\_ Score



# WEBELOS/AOL TARGET

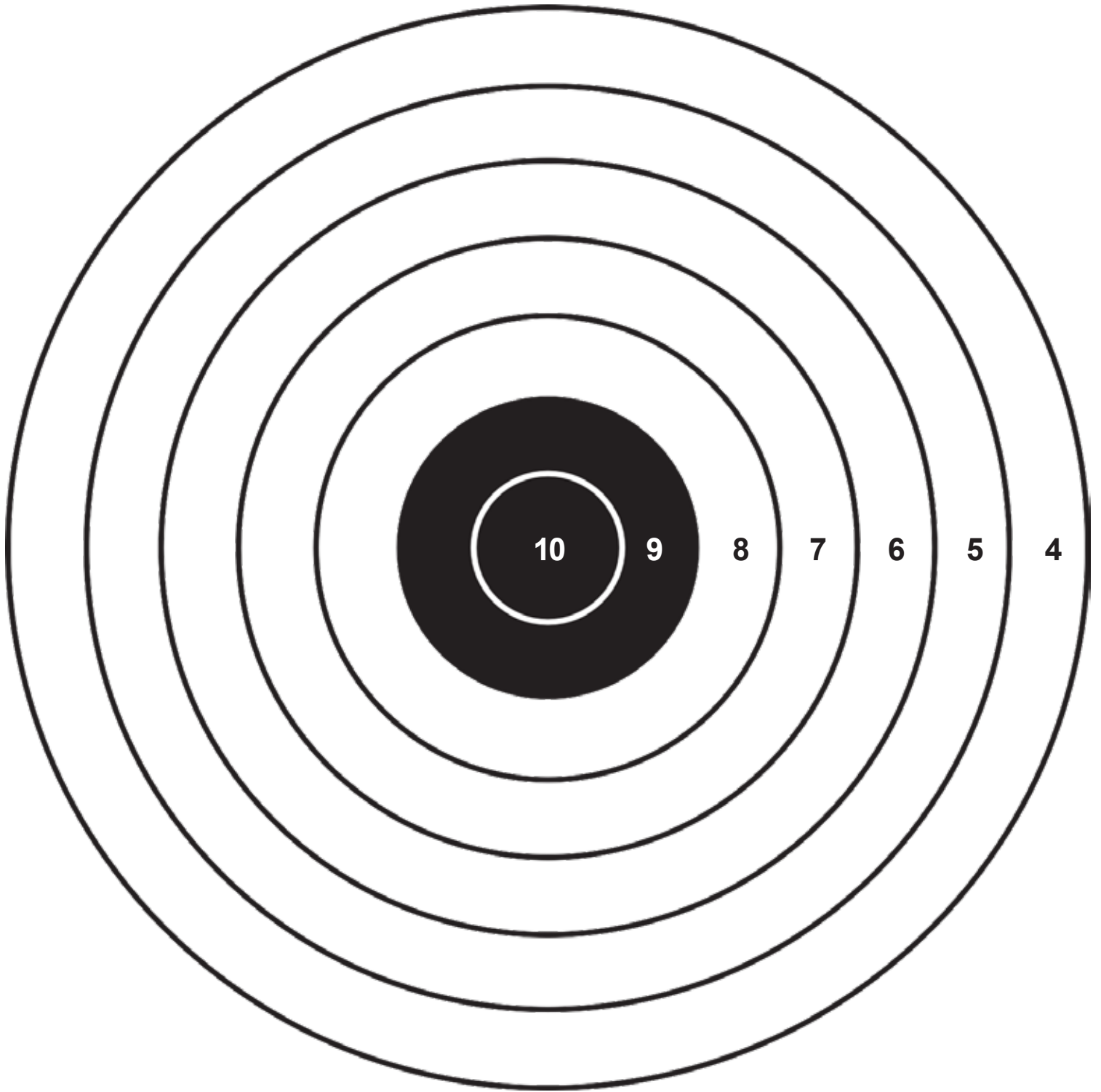

\_\_\_\_\_ Name

\_\_\_\_/\_\_\_\_/\_\_\_\_ Date

\_\_\_\_\_ Score

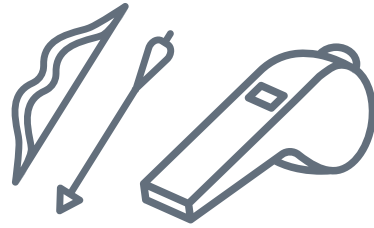

# ARCHERY RANGE RULES AND COMMANDS

## ARCHERY RANGE RULES

1. Always walk on the range.
2. Keep your arrows in your quiver until you are told to shoot.
3. Only release the bow string when an arrow is nocked and safely pointed toward the target.
4. Leave dropped arrows on the ground until instructed to retrieve them.

**If there is an emergency on the range, immediately tell the instructor.**

## WHISTLE COMMANDS

**2 WHISTLE BLASTS = Go to the line.**

**1 WHISTLE BLAST = Shoot.**

**3 WHISTLE BLASTS = Retrieve arrows.**

**5 OR MORE WHISTLE BLASTS = Emergency.** Immediately stop shooting, return bows to the rack, and go behind the waiting line.

(From USAA Archery Certification Course — Level 1 manual. Used with permission.)



# ARCHERY SHOOTING FORM

(Right-handed archer. Reverse instructions for left-handed archer.)

## Square Stance

- Turn sideways to the target, with left shoulder toward the target.
- Distribute weight evenly on both feet, which are shoulder width apart.

## Nock the Arrow

- Lay the shaft of the arrow on the arrow rest, and nock the arrow by fitting the notched end of the arrow just below the string's nocking point.
- Face the odd-colored feather (cock) away from the bow.
- Grasp the arrow by the nock between the thumb and index finger of the right hand.

## Draw

- Bring the left hand up, turning the hand so the bow assumes a vertical position at arm's length.
- With the three fingers of the right hand serving as hooks, start the draw slowly.
- The index finger will be above the arrow and the middle two fingers below it.
- At full draw, the right elbow is back and in direct line with the tip of the arrow.

## Anchor

- At the completion of the draw, the relaxed thumb of the right hand finds an anchor spot under the jawbone.
- Using the jawbone as an anchor, the bowstring will touch the nose and the center of the chin.
- It is important that the anchor point be the same for every shot.

## Release or Loose

- The hand is opened with the fingers moving quickly and precisely off the nock and the string at the same time.
- Keep the left arm in the same position as for a full draw.
- Relax wrist.
- Keep alignment.
- Avoid tension.
- Keep the bow at the same level that it was at full draw.

## Follow Through

- Keep aiming until the arrow hits the target.
- After release, the fingers should not be more than an inch away from and behind the anchor point.
- Hold the position until the arrow strikes the target to make certain the whole process is smooth.
- In a good follow-through, your right hand will be at the back of your neck and your arm will be lined up perfectly.



# TYPES OF ARCHERY BOWS

## RECURVE BOW

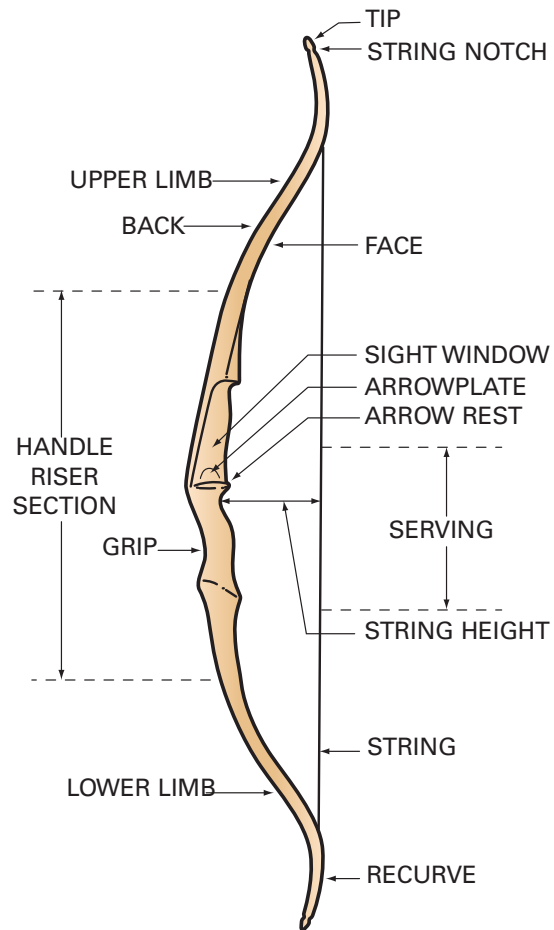

## COMPOUND BOW

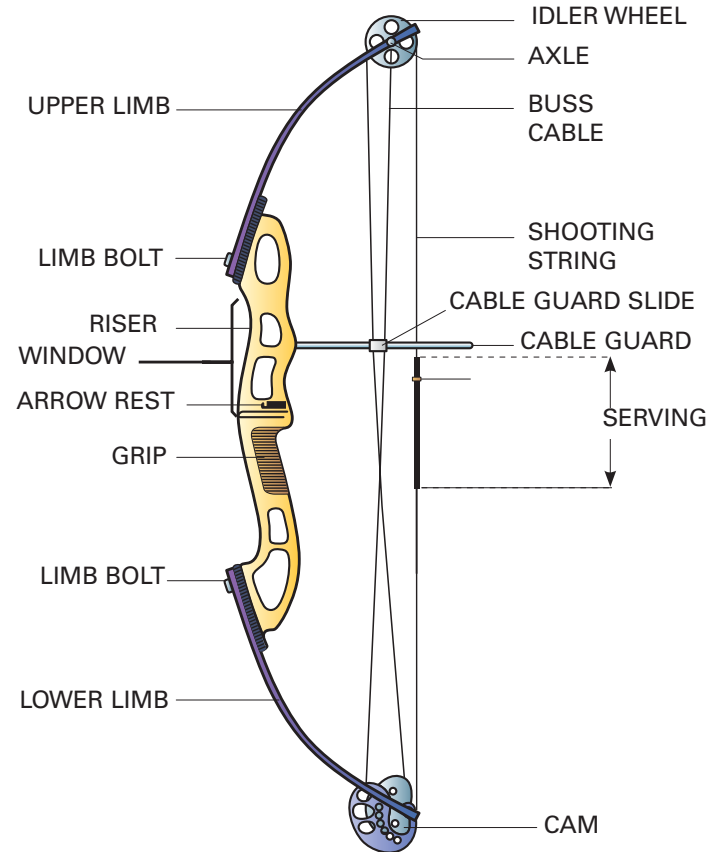



# GENERAL SLINGSHOT RANGE COMMANDS

<b>LOAD.</b>	LOAD YOUR SLINGSHOT.
<b>READY ON THE FIRING LINE.</b>	ALL SHOOTERS ARE READY.
<b>COMMENCE FIRING.</b>	YOU MAY FIRE YOUR SLINGSHOT.
<b>CEASE FIRING.</b>	STOP SHOOTING.





# GENERAL SLINGSHOT RANGE RULES

1. This range may be opened only by a certified Cub Scouts shooting sports range master.
2. All commands issued by the range master must be obeyed immediately.
3. Stay behind the firing line. Do not straddle the firing line.
4. Do not pick up a slingshot unless told to by the range master.
5. Absolutely no running on the range.
6. No horseplay or unnecessary talking on the range.
7. If in doubt about the rules, ask your leader or range master for advice or help.



# SLINGSHOT SAFETY RULES

**ALWAYS** KEEP THE SLINGSHOT POINTED IN A SAFE DIRECTION. YOUR RANGE MASTER WILL TELL YOU WHAT DIRECTION IS SAFE. IF YOU ARE NOT SURE, ASK.

**ALWAYS** KEEP THE BANDS AT REST UNTIL YOU ARE READY TO SHOOT.

**ALWAYS** KEEP THE POUCH AMMUNITION FREE UNTIL READY TO USE.

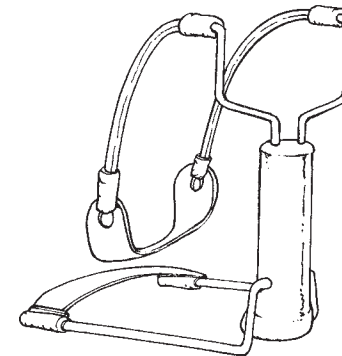



# PARTS OF A SLINGSHOT

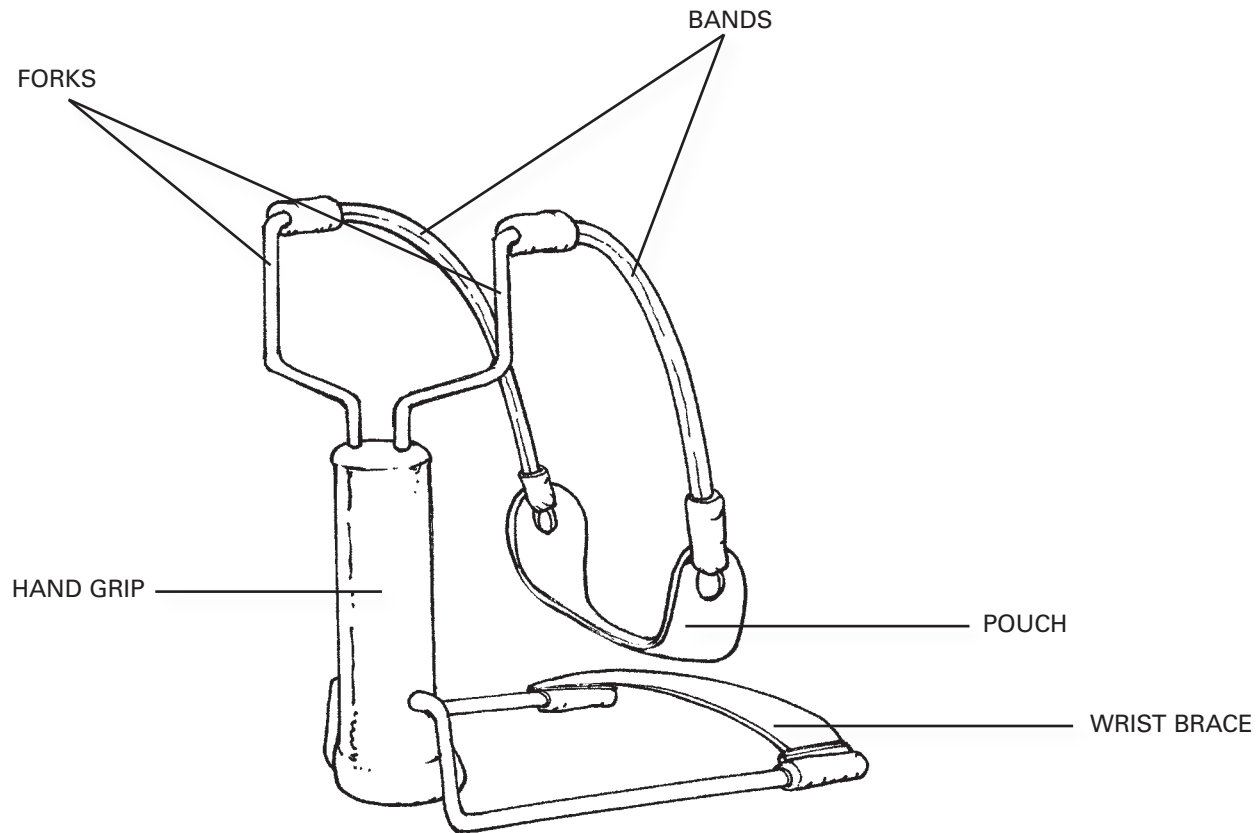

To Pack Advancement Team:

This is to inform you that **Cub Scout** \_\_\_\_\_

has completed the requirements for the Cub Scout Shooting Sports Award as noted below. Please award the patches and devices at your next opportunity.

Rangemaster, please initial the appropriate box(es) below indicating completion of the award.

	<b>BB GUN</b>	<b>ARCHERY</b>	<b>SLINGSHOT</b>
<b>TIGER</b>			
<b>WOLF</b>			
<b>BEAR</b>			
<b>WEBELOS/AOL</b>			

If all the requirements were not finished, please indicate below which ones were completed with your initials.

**BB GUN**

Level 1—1	
Level 1—2	
Level 1—3	
Level 1—4	
Level 2—S1	
Level 2—S2	
Level 2—S3	
Level 2—S4	

**ARCHERY**

Level 1—1	
Level 1—2	
Level 1—3	
Level 1—4	
Level 1—5	
Level 2—S1	
Level 2—S2	
Level 2—S3	
Level 2—S4	

**SLINGSHOT**

Level 1—1	
Level 1—2	
Level 1—3	
Level 1—4	
Level 2—S1	
Level 2—S2	
Level 2—S3	



## APPENDIX 2: ADDITIONAL ACTIVITIES

### Shooting Sports Program Ideas

Shooting sports activities in Cub Scouting are operated by local councils and districts. The suggestions here are designed for use at council- and district-sponsored events that provide shooting sports opportunities.

The activities described below can be used with slingshots, archery equipment, and BB guns. An important practice across all of Scouting is that we do not use targets that feature human beings or animals.

Targets for BBs, arrows, and slingshots can be made from a variety of materials, including paper, cans, plastic bottles, and balloons. Paper targets can be homemade or purchased. Cans are excellent as they make a great sound when hit. Cans, plastic bottles, and balloons can be hung from strings or attached to netting.

The distance between the shooter and the target can be varied depending on the shooter's level of experience. The distance can be increased as skills improve.

### Fun Target Activities for BB Shooting

#### Target Squares

Make 8.5-by-11-inch targets with several squares on each. Put a number in each square. Shooters can see the squares but not the numbers in them. After firing at the page, the shooter adds up the numbers from the squares that his BBs hit. The highest score is the winner.

#### Mystery Dots

Place dots on a target, then shoot at the back side of the target. Count the score from the dotted side.

#### BB Tic-Tac-Toe

Place three rows of three balloons on a target mat. Divide the group into two lines and have them stand in a single file 20 feet from the target. At the signal to shoot, each shooter will shoot one BB and step back. The second and each succeeding person will shoot one at a time. The first team to break three balloons in any line is the winning team.

#### Cracker Shoot

Set up crackers as targets. Have participants shoot at the narrow edges of the crackers.

#### Action BB Gun Shooting Course

Set up an action BB gun shooting course using several games or targets as different stations in the course. Each station could encourage the shooters to use a different shooting position. One station could be used to do maintenance work for the BB gun shooting program.

### Fun Target Ideas for Archery Shooting

#### Archery Tic-Tac-Toe

Place three rows of three balloons on a target mat. Divide the group into two lines and have them stand in a single file 20 feet from the target. At the signal to shoot, each archer will shoot one arrow and step back. The second and each succeeding person will shoot one at a time. The first team to break three balloons in any line is the winning team.

#### Wand Shooting

Place a strip of 1-inch masking tape over the target face from top to bottom. A point is scored when an arrow hits the tape anywhere on the target. Divide the group into two lines, and have them stand in a single file 20 feet from the target. At the signal to shoot, each archer will shoot one arrow and step back. The second and each succeeding person will shoot one at a time. The first team to get two points is the winning team.

#### Shoot the Monster

Participants shoot at a monster face attached or painted on a one-gallon plastic bottle, suspended with shock cord within a tire. The object is to hit the plastic bottle. This event can be scored individually or by den or pack.

#### Spin the Insect

A picture of an insect is glued to a piece of plywood 12 inches square. The plywood is fastened so it will pivot freely around a centered bar set from post to post when struck with an arrow.

## Ring the Bell

Participants shoot at bells through the open end of swinging tires. All tires are swung in unison with a rope tied to the bottom of each tire and extended to an area beyond the limits of firing on the side.

## Football Placekick

A scaled-down goalpost is erected behind a 4-foot-high canvas sheet. From the firing line the archer can see only the top portion of the goalpost uprights. An arrow shot between the uprights above the crossbar scores as a field goal (three points), while an arrow that passes over the canvas and under the crossbar scores as a touchdown (six points). A raised platform should be set up adjacent to the shooting positions so an observer can determine the scoring since the archer is not able to see the lower portion of the goalposts.

## Archery Practice Fun

Any station set up for boys to practice skills is a fun station for the Cub Scouts. Boys have limited times to shoot arrows, so the opportunity to practice at a council camp or event is a great experience for them. A practice station is a simple, basic archery range, but a very fun one for the boys.

Archery stations could also be set up to practice stringing bows or learning how to care for some of the equipment. Helping with some of the archery equipment could be a rainy day activity.

## Action Archery Course

An action archery course could be set up using several of these games as different stations in the course. A drawing of a sample action archery course is available in the *BSA National Shooting Sports Manual*.

## Fun Target Ideas for Slingshot Shooting

### Feed the Monster

Using a large piece of cardboard, sketch a monster. Cut a hole where the monster's mouth is located. Aim to feed the monster.

### Tin Can Alley

Hang tin cans from string. Place them at various heights and distances from the shooting line.

## Tire Target

Hang tires (or hoops) at different heights and distances from the shooting line.

## Ring-a-Ding

Hang bells from strings. Shoot to strike the bells.

## Chart Paper Target

Create a large target with chart paper. Draw circles of different sizes on the chart paper. Apply different scores to the circles, with large circles being worth fewer points.

## Slingshot Target Course

A target course could be set up using several of these games as different stations in the course. A drawing of a sample action archery course is available in the *BSA National Shooting Sports Manual* and can be adapted for a slingshot target course.

## Bikathlon

The bikathlon event is modeled after the winter Olympic biathlon where competitors cross-country ski and shoot rifles. In the bikathlon, the Cub Scouts bike around an off-road course, stop at various points, dismount from the bikes to shoot targets that fall over when struck, and then continue along the course. Though the sport requires a certain amount of strength for the biking portion, the shooting sports activity is the key to the event.

### Setting Up the Course

Make the course approximately one-third of a mile in length, in the form of a loop so the starting line and a finishing line are in the same position. One point along the course becomes the firing line—with a separate position for each racer. Identify each firing point with a color, as assigned to each participant. Place a bike rack in a safe place with easy access. The course should not be in a rocky area, and the instructors should walk it to ensure that all dangerous obstacles have been removed. The course can be an existing track or laid out with cones or rope guides to make sure each biker follows the same route.

## Running the Race

The bicycle is ridden to the shooting point, the youth dismounts, parks the bike, and shoots the targets. The biker shoots at each target until it is hit and knocked over, then remounts the bike and finishes the race. A limit may be imposed on the number of shots for each target and a time penalty imposed if the target is not knocked over.

The youth finishing the race in the shortest time is declared the winner. The key to the event is not only to pedal fast, but also to shoot quickly and accurately.

Shooting is normally done from the standing position but may be changed at the range director's discretion.

Participants are never allowed to ride the course with the gun, arrows, or slingshots. These items are to remain at the firing point at all times.

Every participant is required to attend a brief orientation on bike safety and handling the shooting sports materials used on the course before being allowed to participate in the bikathlon.

## EQUIPMENT AND MATERIALS

Bikes

Elbow and knee guards

Safety helmets

Stopwatch or other timing device

Cub Scout Shooting Sports Award certificates

BB approach:

BB guns and BBs at each shooting station

Safety glasses to be worn at the firing line

Archery approach:

Bow and quiver of arrows at each shooting station

Slingshot approach:

Slingshot and ammunition at each shooting station

Alternative:

Use all of the above at different stations.

## PERSONNEL

Assign adults to the following positions:

- Match director (responsible for the event)
- Jury (three people who are responsible for solving any dispute that may arise during the match and to ensure compliance of the rules by participants)
- Range masters (responsible for safety on the range)
- Statistical officer (responsible for tracking participants' total lapse time)
- Starter (the official who starts each relay or heat)
- Other personnel needed are timers, first-aid personnel, course marshals, and repair personnel (for guns, arrows, slingshots, and/or bikes).
- One staff member at each station



This safety session should, as a minimum, cover the following:

- Course layout and general rules
- Range procedure and safety
- How the match is scored
- How to operate and load the guns
- Shooting safety and safe gun handling
- Basics of sighting and shooting
- Bicycle use and riding safety
- Hands-on practice as time, personnel, equipment, and facilities allow

## ACKNOWLEDGMENTS

The Boy Scouts of America would like to sincerely thank all volunteers and professionals that contributed to this project. The dedication of the Cub Scout Program Development Task Force, USA Archery, and National Rifle Association is greatly appreciated. In addition, a special thank you goes out to the 2015 Philmont Training Center staff and faculty who were invaluable in the pilot of the Cub Scout Shooting Sports Award requirements.

## PHOTO AND ILLUSTRATION CREDITS

All photos and illustrations are the property of or are protected by the Boy Scouts of America.

BSA file—cover, pages 18, 19, 22 (*arrow*)

Phil Davis—page 26 (*both*)

Nate Luke Photography—page 23

John McDearmon—page 14 (*shooting positions*), 17, 22 (*bow*), 36

Michael Roytek—pages 5, 11, 20, 30